



Hebei Charlotte Enterprise Co., Ltd

Specialized in insect screens, building an international brand.



For more information, please scan the left QR code to view the website information.

HEBEI CHARLOTTE ENTERPRISE CO., LTD

ADDRESS: WUQIANG INDUSTRIAL ZONE, HENGSHUI CITY, HEBEI, CHINA 053300

TEL: 0311-87729880 FAX: 0311-87823630

E-MAIL: INFO@CNSCREENING.COM

HTTP://WWW.CNSCREENING.COM





INTEGRITY PROFESSIONALISM

INNOVATION WIN-WIN

Company Profile



180 million
Gross investment

Founded as a national high-tech enterprise, Hebei Charlotte Enterprise Co., Ltd. is a comprehensive player integrating R&D, production and sales. With a total investment of RMB 180 million and a registered capital of RMB 50 million, the company boasts a modern ecological production base covering 57,000 square meters and employs over 300 professionals. We deeply engage in aluminum-plastic doors and windows, mosquito-proof screens, shading systems, and photovoltaic bracket accessories, providing one-stop high-end building material solutions for global clients.

50 million
Registered Capital

57,000
square meters
production base

Guided by market demands and driven by technological innovation, we adhere to the business philosophy of "Integrity-Based, Quality-First, Safety-Oriented" and fulfill our mission of "Creating Long-Term Value for Customers" through premium services.

As an BSCI internationally certified tech-based SME, we have established long-term strategic cooperation with top 100 global building material retailers and industry leaders, earning customer trust worldwide with stringent quality standards.

Currently, we serve as a core supplier to numerous listed enterprises including JA Solar and Yingli Solar. Our products are exported to dozens of countries and regions across Europe, the Americas, Oceania, the Middle East and beyond, consistently delivering high-quality, high-reliability building materials and services for global construction projects.

We sincerely welcome friends from all over the world to join hands with Charlotte for win-win cooperation and a prosperous future!

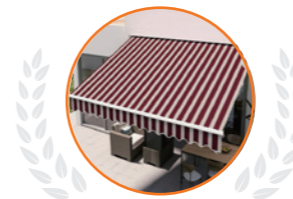

200,000+

sets (per year)

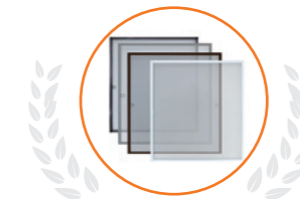

2,000,000+

sets (per year)



20,000,000+

Square meters(per year)

Part 1

01

ENTERPRISE STRENGTH

Extrusion Workshop	01
Aluminum Profile Surface Treatment Workshop	01
Screen Woven Workshop	02
Assembly, Warehouse & Shipping	02
Artisan Quality, Proven Excellence	03

Part 2

02

DIY FLY SCREEN WINDOW AND DOOR WITH FRAME

Roller Screen Window & Door	05
Fixed Screen Window & Door	12
Pleated Screen Window & Door	16
Sliding Screen Window & Door	20

Part 3

03

ECONOMIC FLY SCREEN WINDOW AND DOOR

Magnetic Door Curtain	26
Magnetic Screen Window	29
Insect Screen for Door and Window	31
Mosquito Net	35

Part 4

04

SCREEN MATERIALS, REPAIR SUPPLIES & ACCESSORIES

NewGeneration Self-Extinguishing Insect Screens	38
Standard Fiberglass Insect Screens	39
Fiberglass Insect Mesh – Multi-Field Protection	40
Multi-Material Insect Screen Series	41
Spline, Tools & Repair Parts	42
Repair Tape & Patches	43

Part 5

05

ELECTRIC INSECT&MOSQUITO KILLER SERIES

Electric Bug Zapper	44
UV Insect Killer Lamp	45
Rechargeable Electric Mosquito Swatter	45

Part 6

06

ALUMINUM PROFILE & ACCESSORIES

Surface-Mounted Cabinet Handle Profiles	48
Multi-Purpose Aluminum Trim Profiles	49
Flat-Edge Cabinet Handle Profiles	50
Solar PV Frame & Bracket Aluminum Profiles	50

CONTENTS

01 ENTERPRISE STRENGTH

Extrusion Workshop



Aluminum Profile Surface Treatment Workshop



Screen Woven Workshop



Assembly, Warehouse & Shipping

The assembly workshop demonstrates our efficient manufacturing processes with multiple workstations and skilled technicians. Our production floor is equipped with advanced tools and organized workspaces, that ensure precision assembly and quality control at every stage. The collaborative environment fosters teamwork and streamlined production workflows.

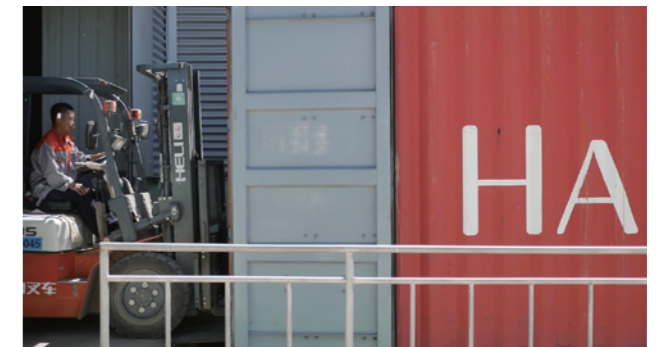

Artisan Quality Proven Excellence



This exhibition room showcases window screens, sun shades, screen doors and related products.

It is a dedicated display space for physical samples, presenting product quality, appearance and practical functions.

With well-organized display and complete product series, it allows customers to visually experience the sun-shading, mosquito-proof and breathable performance of our products, and facilitates product selection and business communication.

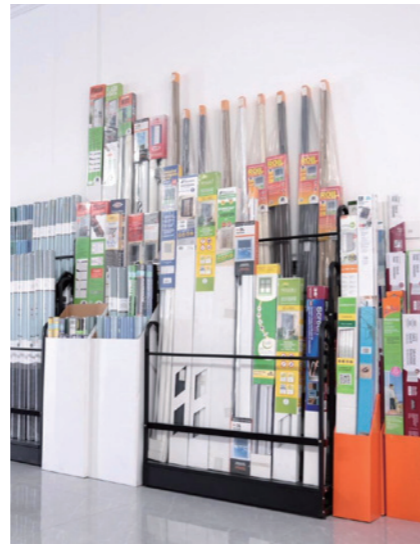

02

DIY Fly Screen Window & Door With Frame



RSW001- Standard Roller Screen Window

DIY Fly Screen Window & Door With Frame



PRODUCT INTRODUCTION

1. All accessories are in line with REACH standard, High-quality aluminum alloy
2. Environmental fiberglass screen, tear proof to ensure a long service life
3. Wind-Resistant Weather strip and cushion are optional
4. DIY design and 5.8m pre-assembled rails are available

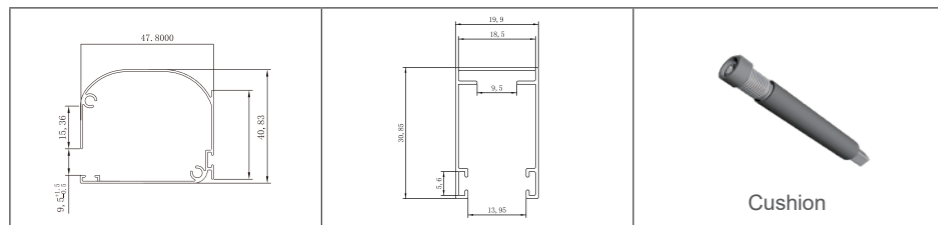

Color for you

White Brown Anthracite Bronze

Different size

80x150cm 100x150cm 140x170cm 160x170cm

Custom colors and sizes are available.

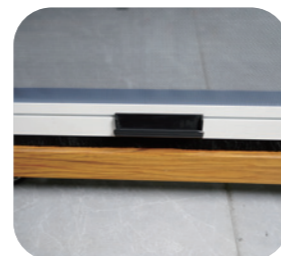

RSD001-Standard Roller Screen Door

DIY Fly Screen Window & Door With Frame



PRODUCT INTRODUCTION

1. All accessories are in line with REACH standard, High-quality aluminum alloy
2. Environmental fiberglass screen, tear proof to ensure a long service life
3. Wind-Resistant Weather strip and Cushion are optional
4. DIY design and 5.8m pre-assembled rails and Double door are available

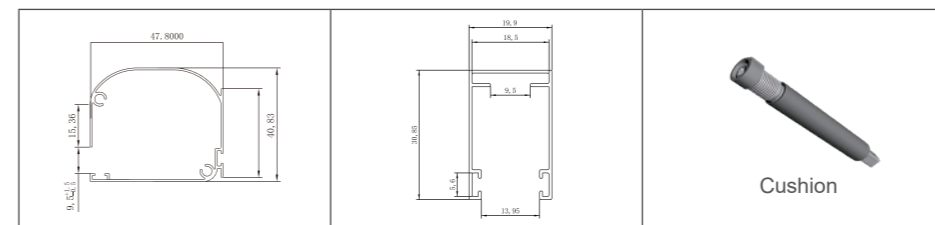

Color for you

White Brown Anthracite Bronze

Different size

130x230cm 120x240cm 150x250cm

Custom colors and sizes are available.



RSW002-Roller Screen Window Plus+

DIY Fly Screen Window & Door With Frame



PRODUCT INTRODUCTION

1. Stronger aluminum alloy profiles
2. All accessories are in line with REACH standard
3. Environmental fiberglass screen, tear proof to ensure a long service life
4. Easy to adjust to retract speed of mesh based with hand shank
5. Wind-Resistant Weather strip and Cushion are optional
6. DIY design and 5.8m pre-assembled rails are available

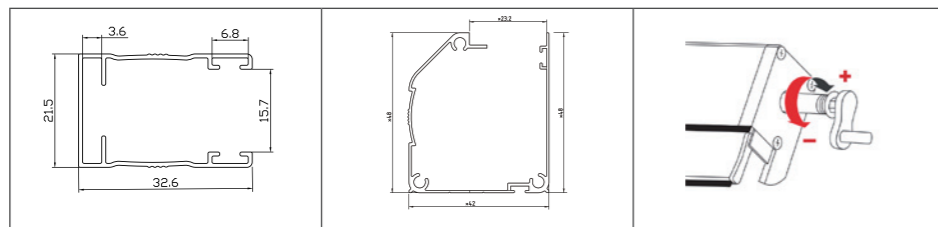

Color for you

White Brown Anthracite Bronze

Different size

80x150cm 100x150cm 140x170cm 160x170cm

Custom colors and sizes are available.



RSD002-Roller Screen Door Plus+

DIY Fly Screen Window & Door With Frame



PRODUCT INTRODUCTION

1. Stronger aluminum alloy profiles
2. All accessories are in line with REACH standard
3. Environmental fiberglass screen, tear proof to ensure a long service life
4. Easy to adjust to retract speed of mesh based with hand shank
5. Wind-Resistant Weather strip and Cushion are optional
6. DIY design and 5.8m pre-assembled rails and Double door are available

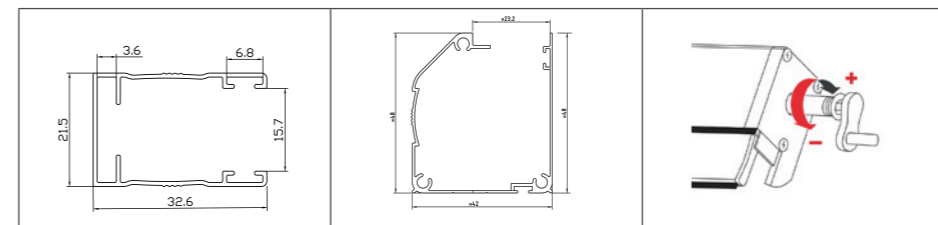

Color for you

White Brown Anthracite Bronze

Different size

130x230cm 120x240cm 150x250cm

Custom colors and sizes are available.



RSW003-Roller Screen Window Without Drilling



PRODUCT INTRODUCTION

1. All accessories are in line with REACH standard, High-quality aluminum alloy
2. Environmental fiberglass screen, tear proof to ensure a long service life
3. Easy installation, no drilling required, no damage to walls,
4. Suitable Inside mounting for any window, even irregular windows

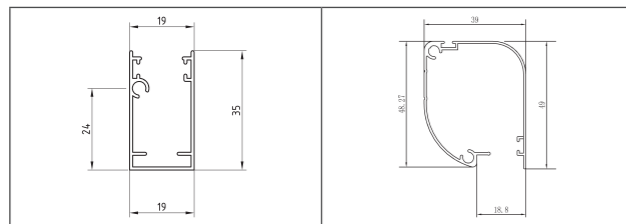

Color for you

White Anthracite

Different size

80x150cm 100x150cm 140x170cm 160x170cm

Custom colors and sizes are available.



RSW004-PVC Roller Screen Window



PRODUCT INTRODUCTION

1. All accessories comply with REACH standards
2. Environmentally friendly fiberglass mesh, tear resistant, ensuring long service life
3. PVC Profile with fiberglass screen, Low price and affordable
4. Wind resistant sealing strips are optional
5. DIY Design, standard style with aluminum handle bar

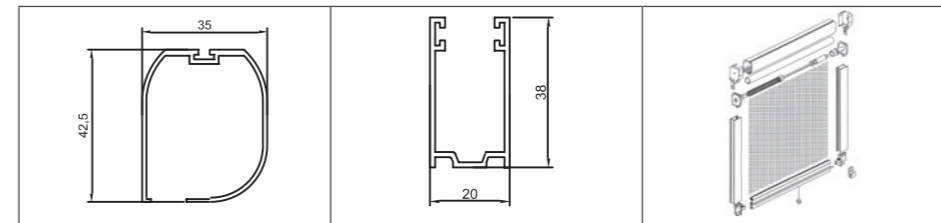

Color for you

White Anthracite

Different size

80x150cm 100x150cm 140x170cm 160x170cm

Custom colors and sizes are available.



RSD003-PVC Roller Screen Door



PRODUCT INTRODUCTION

1. All accessories comply with REACH standards
2. Environmentally friendly fiberglass mesh, tear resistant, ensuring long service life
3. PVC Profile with fiberglass screen, Low price and affordable
4. Wind resistant sealing strips are optional
5. DIY Design, standard style with aluminum handle bar

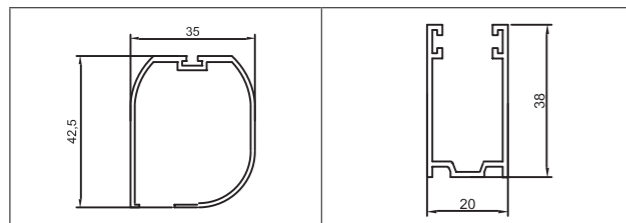

Color for you

White Anthracite

Different size

130x230cm 120x240cm 150x250cm

Custom colors and sizes are available.



FSW001-Fixed Screen Window With Metal Hook



PRODUCT INTRODUCTION

1. All accessories are in line with REACH standard, High-quality aluminum alloy
2. Environmental fiberglass screen, tear proof to ensure a long service life
3. No-drill, mounting hooks can be curved into different sizes to fit window frame size
4. Easy to fix on or take down with 2 plastic handles
5. DIY design and 5.8m pre-assembled rails are available

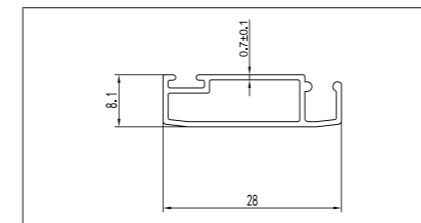

Color for you

White Brown Anthracite

Different size

100x100cm 130x150cm 140x140CM

Custom colors and sizes are available.

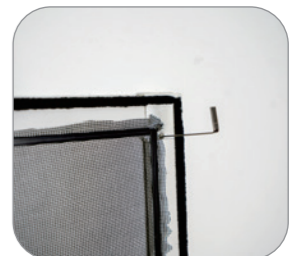

FSD001-Fixed Screen Door



PRODUCT INTRODUCTION

1. All accessories are in line with REACH standard, High-quality aluminum alloy
2. Environmental fiberglass screen, tear proof to ensure a long service life
3. Closing with magnetic and weather strip makes a better windproof
4. Self-closing plastic hinges (coiling spring integrated into the casing) for added protection
5. DIY design, 5.8m pre-assembled rails, and two ways mounting are available

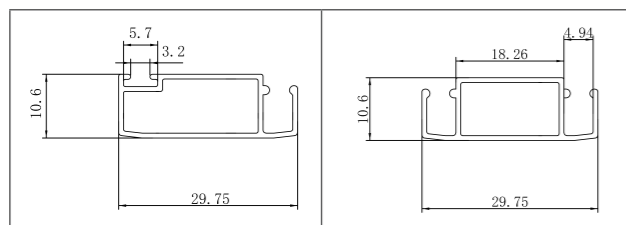

Color for you

White Brown Anthracite

Different size

100x210cm 100x215cm 120*240cm

Custom colors and sizes are available.

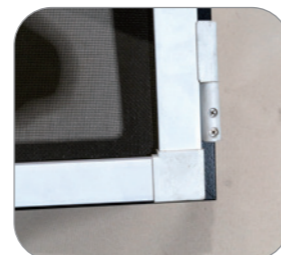

FSW002-Fixed Screen Window Plus+



PRODUCT INTRODUCTION

Stronger aluminum alloy profiles .

The screen window adopts stainless steel hardware accessories, with the core advantages of being invisible and transparent, durable, easy to install, safe, and easy to maintain.

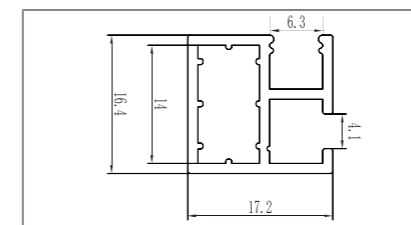

Color for you

White Anthracite

Different size

100x100cm 130x150cm 140x140CM

Custom colors and sizes are available.



FSW003- Fixed Screen Window With Spring



PRODUCT INTRODUCTION

1. A great choice for both function and style.
2. Easy to install with 5 easy steps .
3. Economical and practical, Customizable production.

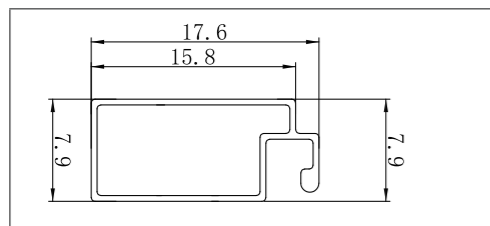

Color for you

White Brown Mill Matte Black

Different size

100x100cm 130x150cm 140x140CM

Custom colors and sizes are available.



PSW001-Single Pleated Screen Window



PRODUCT INTRODUCTION

1. Effective natural insect protection.
2. Optimal ventilation & light transmission.
3. Easy to size & assemble.
4. Open tilt windows – no mosquitoes, flies, wasps
5. Simple, easy to install, and no tripping hazard for children.

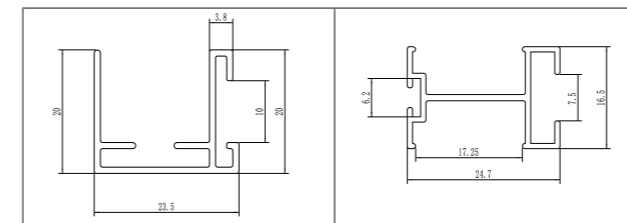

Color for you

White Brown Anthracite

Different size

Width : 80-140cm Height : 160-170cm

Custom colors and sizes are available.



PSW002-Double Pleated Screen Window



PRODUCT INTRODUCTION

1. Combined sun protection and insect protection.
2. Reliable protection against overheating of rooms.
3. High stability thanks to high-quality profiles. The stable guide path ensures an ideal fixing effect.
4. Insect protection and sun protection in one.
5. Easy operation & quick installation.
6. Multiple sizes – a perfect fit for opening.

Color for you

White
 Brown
 Anthracite

Different size

Width : 80-160cm Height : 160-210cm

Custom colors and sizes are available.

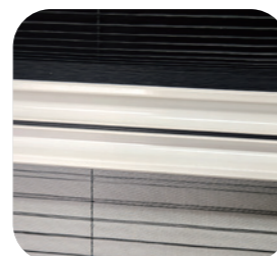
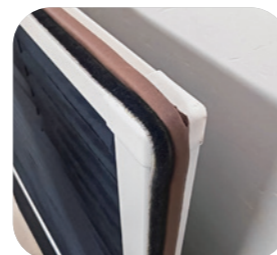

PSD001-Low Threshold Pleated Screen Door



PRODUCT INTRODUCTION

1. Pleated insect screen – comfortable, reliable & elegant. It is a high-end mosquito and insect screen door.
2. 5mm Low Threshold – reduces tripping hazard, safer for kids & elderly; easy to clean, no dust traps.
3. High-toughness PPE mesh – wear-resistant, anti-aging, less deformation; more durable than standard screens.
4. Easy open/close, folds flat – saves space; blocks insects & dust without blocking ventilation or light.

Color for you

White
 Brown
 Anthracite

Different size

Width : 120cm Height : 220-240cm

Custom colors and sizes are available.

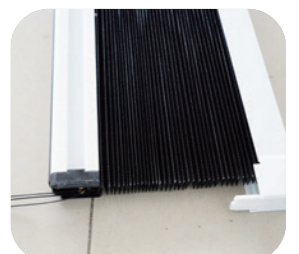
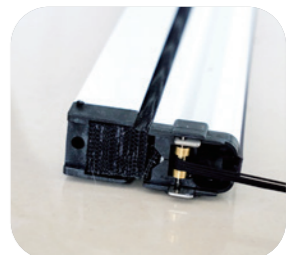

PSD002-Chain-Driven Pleated Screen Door



PRODUCT INTRODUCTION

1. The chain can be fully stored in the side frame, achieving trackless passage, without tripping or accumulating dust, making entry and exit smoother.
2. High toughness PPE folding window screen is adopted, which is durable, anti-aging and not easy to deform.
3. The overall disassembly and assembly is convenient, without the need for complex tools, easy installation and maintenance, and combines aesthetics and practicality. It is an ideal choice for insect proof screen doors in homes, balconies, and shops.

Color for you

White Brown grey

Different size

Width : 100-150cm Height : 210-240cm

Custom colors and sizes are available.

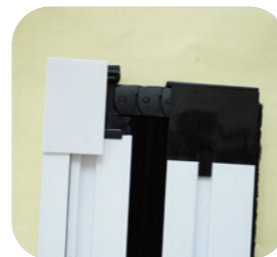

SSW001-Sliding Screen Window With Brush



PRODUCT INTRODUCTION

1. Aluminum frame with fiberglass screen: sturdier and more durable
2. Adjustable, expandable, removable and washable.
3. Easy to install in seconds; no tools or drilling required. Ready to use right out of the box.
4. Suitable for living rooms, bedrooms, kitchens, balconies and other spaces.
5. Multiple sizes available; can be mounted horizontally or vertically Double sided
6. Optional with or without weather stripping.

Color for you

White Brown Anthracite

Different size

40x50cm / 50x70cm / 70x100cm

Custom colors and sizes are available.



SSW002-Sliding Screen Window Without Brush



PRODUCT INTRODUCTION

1. Aluminum frame with fiberglass screen: sturdier and more durable
2. Adjustable, expandable, removable and washable.
3. Easy to install in seconds; no tools or drilling required. Ready to use right out of the box.
4. Suitable for living rooms, bedrooms, kitchens, balconies and other spaces.
5. Multiple sizes available; can be mounted horizontally or vertically Double sided
6. Optional with or without weather stripping.

Color for you

White Brown Bronze Natural

Different size

40x50cm / 50x70cm / 70x100cm

Custom colors and sizes are available.

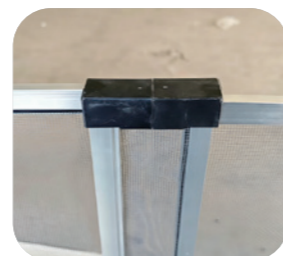
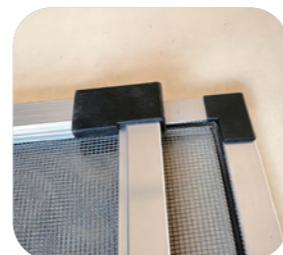

SSW003-PVC Sliding Screen Window



PRODUCT INTRODUCTION

1. PVC frame with fiberglass screen: More beautiful
2. Adjustable, expandable, removable and washable.
3. Easy to install in seconds; no tools or drilling required. Ready to use right out of the box.
4. Suitable for living rooms, bedrooms, kitchens, balconies and other spaces.
5. Multiple sizes available; can be mounted horizontally or vertically.

Color for you

White Brown Anthracite

Different size

33.5x 48.5cm / 40x50cm / 50x70cm

Custom colors and sizes are available.



SSD001-Single Sliding Insect Screen Door



PRODUCT INTRODUCTION

1. Flexible installation – mounts on wall bay windows or door frames.
2. Wide application – works for double patio doors or wide hinged doors.
3. Smooth operation – high-quality guide rails for easy opening & closing.

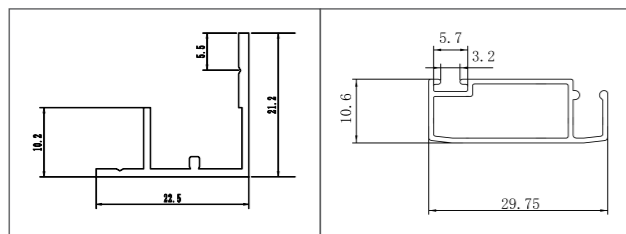

Color for you

White Brown Anthracite

Different size

Width : 120cm Height : 240cm

Custom colors and sizes are available.

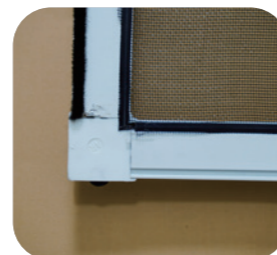

SSD002-Double Sliding Insect Screen Door



PRODUCT INTRODUCTION

1. Space-saving sliding screen door – ideal for large (double) patio/balcony doors.
2. High-transparency fiberglass mesh – nearly invisible, blocks insects while allowing airflow.
3. Smooth sliding – flat bottom rail + top rail rollers.
4. Stable screw installation – two separate kits can be installed as double doors.

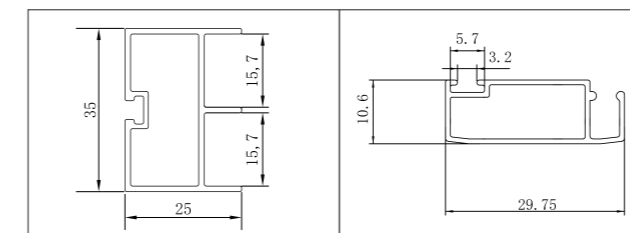

Color for you

White Brown Anthracite

Different size

Width : 240cm Height : 240cm

Custom colors and sizes are available.



03

Economic Fly Screen For Window And Door

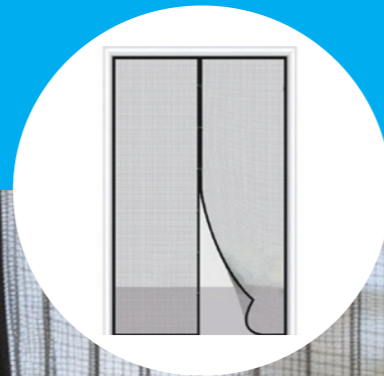

MDC -001 Luxury Magnetic Door Curtain



Economic Fly Screen For Window And Door

PRODUCT INTRODUCTION

Material: 100% Polyester (55gsm), Fiberglass or PPE optional

Easy Installation: Full-frame magic tape design, no tools required. Simply peel off the adhesive backing of the hook and loop strips and attach them to the door frame.

Equipped with powerful magnetic cubes, the mesh screen door can be opened easily and closed seamlessly.



HANDS-FREE
ENTRY



PET
FRIENDLY



KID
FRIENDLY

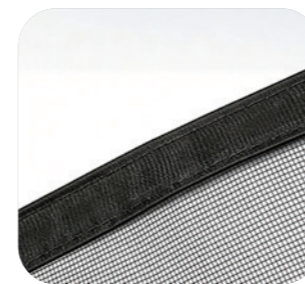

normal size(W×L)	Color	packing
100x220cm	black / white / grey	color box packing , polybag packing or follow customer request.
120x250cm		
130x230cm		
140x250cm		
by customer request size		

MDC -002 Popular Magnetic Door Curtain



PRODUCT INTRODUCTION

Economical and Practical

Material: 100% Polyester, 38gsm, 50gsm optional

Magnetic Options: Popular style with Individual magnetic bar , still you can Choose individual magnet strip or a combination of magnetic strip and magnet bar

Easy Installation: Installed with hook and loop fastening tape, simple to operate.



HANDS-FREE ENTRY



PET FRIENDLY



KID FRIENDLY

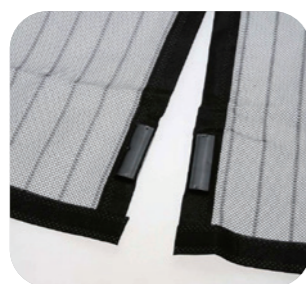

normal size(W×L)	Color	packing
100x210cm	black / white / grey	color box packing , polybag packing or follow customer request.
120x240cm		
130x230cm		
150x250cm		
38inx83in		

Garage Door Curtain



PRODUCT INTRODUCTION

Ultra-durable fiberglass is resistant to tearing, fire, light.breathable, corrosion-resistant.Easy to install & full frame magnetic tape tip.

No tools required, simply peel the adhesive backing off the hook and loop strips and apply to door frame.

Powerful magnetic cubes that allow the garage mesh screendoor to open easily and close seamlessly.

Perfect for increasing airflow in your home, and its good transmittance can give you a better vision.

Provide the best and friendliest customer service.



normal size(W×L)	Color	packing
283x218cm	black / white / grey	color box packing , polybag packing or follow customer request.
274x213cm		
by customer request size		

Magnetic Screen Window



Hard frame profiles

PRODUCT INTRODUCTION

DIY instaling, and Automatic closure. Provide 100% perfect seal against any insects.

Suit Timber, Aluminium, steel, and hard PVC frames

hard frame profiles

Easy to remove or open for cleaning and switching window

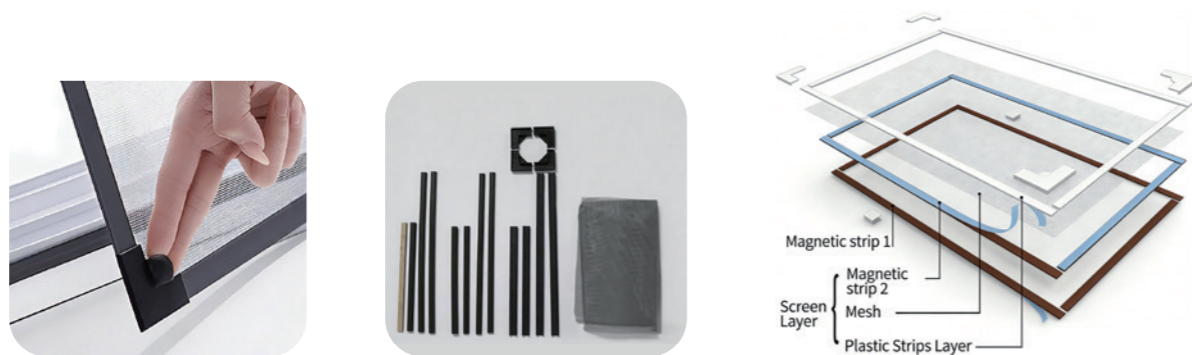

normal size(W×L)	Color	packing
100x120cm	black / white	color box packing , polybag packing or follow customer request.
100x150cm		
130x150cm		
by customer request size		

Magnetic Screen Window



Soft frame profiles

PRODUCT INTRODUCTION

DIY instaling, and Automatic closure. Provide 100% perfect seal against any insects.

Suit Timber, Aluminium, steel, and PVC frames

Frame is soft, can be flexibly bended

Easy to remove or open for cleaning and switching window



normal size(W×L)	Color	packing
100x120cm	black / white	color box packing , polybag packing or follow customer request.
100x150cm		
130x150cm		
by customer request size		

DC-001 Luxury Insect Door Curtain



PRODUCT INTRODUCTION

Material : 100% polyester

Specification : 4 pcs , 5 pcs or 6 pcs door curtain with PVC profiles, with accessory fixed in screw , removeable at any time can be shortened individually in width and height

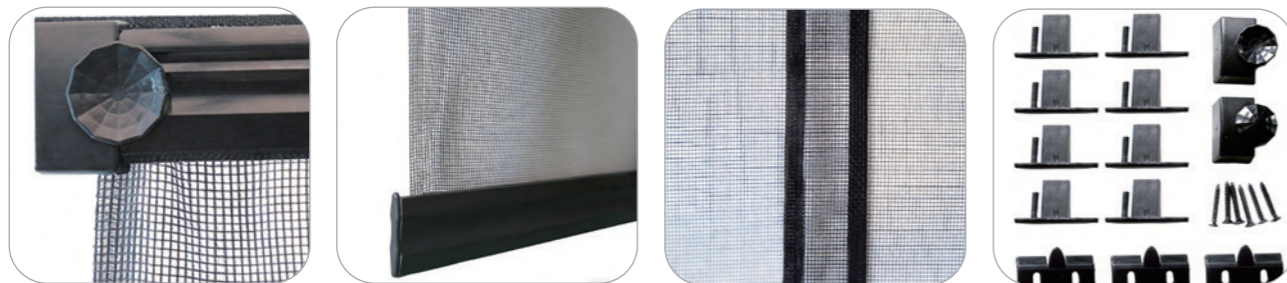

normal size(W×L)	Color	packing
4 pcs x 28.5x 210cm/ 230cm/250cm	black / white / grey	color box packing , polybag packing or follow customer request.
5pcs x 28.5x 210cm/ 230cm/250cm		
6pcs x 28.5x 210cm/ 230cm/250cm		
by customer request size		

DC-002 Standard Insect Door Curtain



PRODUCT INTRODUCTION

Material : 100% polyester or fiberglass or PPE screen

Specification : 4 pcs , 5 pcs or 6 pcs door curtain with optional various styles PVC profiles fixed in velcro fastening , removeable at any time can be shortened individually in width and height

OPTION

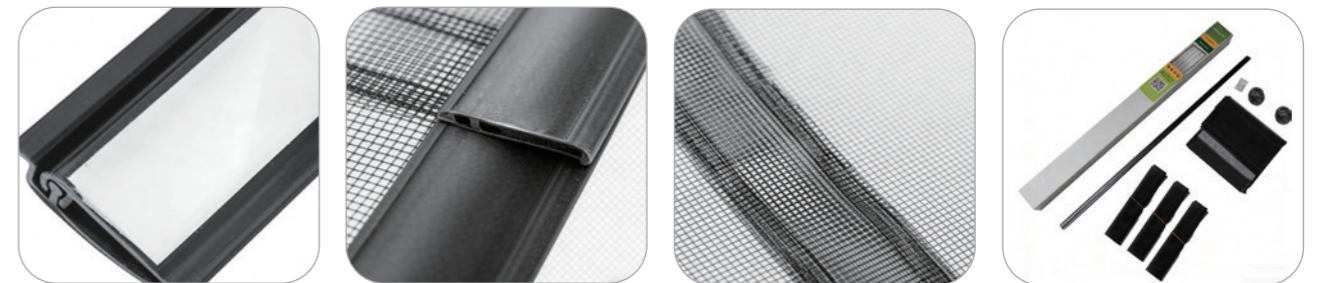
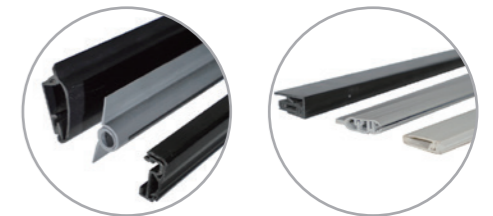

normal size(W×L)	Color	packing
4 pcs x 28.5x 210cm/ 230cm/250cm	black / white / grey	color box packing , polybag packing or follow customer request.
5pcs x 28.5x 210cm/ 230cm/250cm		
6pcs x 28.5x 210cm/ 230cm/250cm		
by customer request size		

Polyester Fly Screen With Velcro Tape For Door



PRODUCT INTRODUCTION

Material : 100% polyester **SQUARE** hole
Weight : 23gsm, 25gsm, 28gsm, 30gsm, 40gsm
Material : 100% polyester **HEXAGONAL** hole
Weight : 18gsm, 23gsm, 25gsm, 30gsm
Specification :
 2 pcs door curtain
 2 overlapping Polyester-Lamellar
 2 line-weight sewing at the bottom.
 with velcro tape



normal size(W×L)	Color	packing
2x 65x220cm	black white grey	color box packing, polybag packing or follow customer request.
2x75x210cm		
2x75x230cm		
2x75x250cm		
by customer request size		

Polyester fly screen with velcro tape for window



PRODUCT INTRODUCTION

Material : 100% polyester **SQUARE** hole
Weight : 23gsm, 25gsm, 28gsm, 30gsm, 40gsm
Material : 100% polyester **HEXAGONAL** hole
Weight : 18gsm, 23gsm, 25gsm, 30gsm



normal size(W×L)	Color	packing
100x100cm	black white	color box packing, polybag packing or follow customer request.
130x150cm		
150x180cm		
170x180cm		
by customer request size		

Pollen Proof Screen

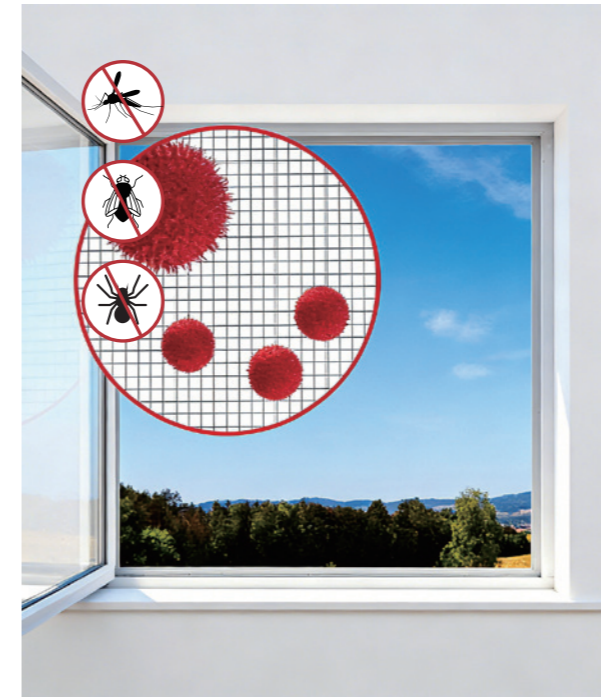

PRODUCT INTRODUCTION

Polyester material
 Protect against pollen dust
 Best transparency high air permeability
 Suitable for people with allergies.

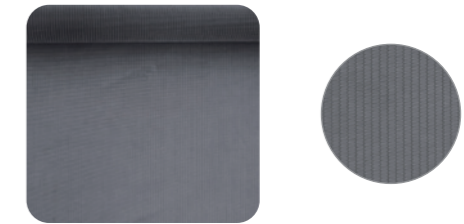

size option (W×L)	Color
130x150cm	Black / Grey
150x180cm	

Fly Screen For Skylight



PRODUCT INTRODUCTION

Suitable for any window,with zipper, reflection
 fine stretchy fabrics with silver coated, protectagainst
 various insects



- insect stop
- Sunshine protection
- Heat protection
- Privacy protection

size option (W×L)	Color
130x150cm	Black / Sliver
150x180cm	
150x300cm	

Mosquito Net For Bed



PRODUCT INTRODUCTION

The mosquito net guarantees travelers to exotic destinations a good sleep. And with good mosquito repellent effect in outside and inside.



size option (W×L)	Color
2.2x8.5cm	White / Pink / Blue Customized
2.5x12.5cm	
150x200x150cm	
180x200x150cm	

Mosquito Net For Food



PRODUCT INTRODUCTION

It can be folded, easy for use, with light wire frames open and close instantly like an umbrella.



MATERIAL: polyester

Mosquito Net For Pushchair



PRODUCT INTRODUCTION

The frame material is thick steel, strong & durable
The screen hole spacing is equal, great ability of light transmission
Spray paint anti-rust treatment



size option (W×L)	Color
120x140cm	White

MATERIAL: polyester

Mosquito Net For Head



PRODUCT INTRODUCTION

Protect you from the tiniest bugs, excellent ventilation and excellent visibility, premium quality, superior airflow.



size option (W×L)	Color
43x40cm	Green / Black Customized

PACKAGE OPTION: 6×6×8cm

04

Screen Materials, Repair Supplies & Accessories



New Generation Self-Extinguishing Insect Screen



Innovative

INTRODUCTION

Material: Innovative PP+PE Composite
Mesh: 18X18/20X20/24X24/26X26
(Customizable)
Core Breakthrough: Patented Self-Extinguishing
Flame Retardancy
Installation: Tool-Free, Quick DIY Setup

COLOR | customizable

 Black  Grey  White

SIZE | customizable

Width ≤3.1m (Seamless)
Length: 2.05m/2.14m/6m/7.62m/25m/30m/50m
Custom: Exact Dimensions Available (Cut-to-Size Supported)

ADVANTAGE

- **[Superior Light Transmittance]** Crystal-clear view, maximum natural light.
- **[Eco-Friendly & Recyclable]** PVC-Free, green & sustainable.
- **[Long Service Life]** UV-stable, weather-resistant, durable for years.
- **[Family-Safe]** Non-toxic, odorless, no harmful chemicals.
- **[Global Compliance]** Meets EU REACH, US/CA Prop 65 standards.
- **[Versatile Use]** Ideal for dormer/skylight/casement windows.
- **[Cost-Effective]** High value, low-cost for bulk orders.

Revolutionary Flammability Resistance
Patented self-extinguishing formula stops burning instantly.

Standard Fiberglass Screens



Standard Screen

INTRODUCTION

Material: Fiberglass yarn + PVC coated
 Specs: 18X14 mesh, 18X16 mesh
 Mesh Weight: 110-115gsm
 Thread Diameter: 0.25mm

COLOR | customizable

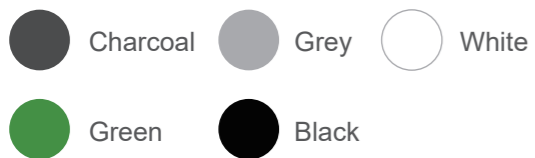

SIZE | customizable

Width ≤3.1m (Seamless)
 Length: 2.05m/2.14m/6.05m/7.62m /30m /50m
 Custom: Exact Dimensions Available (Cut-to-Size Supported)

ADVANTAGE

Fire resistant
 Material recycle eco-friendly
 Cost economy
 Easy to clean

APPLICATION

Window protection for buildings, pastures, orchards, insect and mosquito repellent facilities, as well as office buildings, residential buildings, and other structures



Fiberglass Insect Screen – Multi-Field Protection



CRYSTAL CLEAR SCREEN

It is wrinkle free, fire-resistant, washable, and abrasion resistant.
 20X20 mesh

Colour Options :

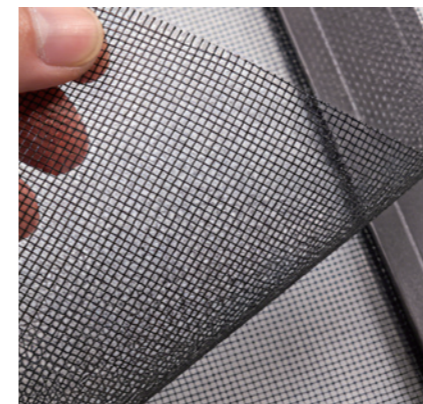

EXTRA STRENGTH SCREEN

It's more durable and has good ventilation.
 18X14 mesh

Colour Options :



POOL & PATIO SCREEN

It's used for large opening such as pool & patio enclosures.
 18X14 mesh

Colour Options :



SMALL BUG SCREEN

It can keep out small insects, and has tightly-woven mesh,
 20X20mesh

Colour Options :



Multi-Material Insect Screen Series



ALUMINUM SCREEN

Baked Enamel process improves the durability, corrosion resistance, and color rendering of the product
18X16 mesh, 160-165gsm

Colour Options :



STAINLESS STEEL SCREEN

Stronger, more durable and longer-lasting
More flexible and pliable
Perfect high transparency, fire retardant and oil resistant
18X16 mesh 340gsm

Colour Options :



PET SCREEN

It's made of durable polyester and has excellent outward visibility.
It can resist damage by dogs & cats.
15X10 mesh 360gsm

Colour Options :



SUN SCREEN

It's made of fiberglass or polyester to protect against the sun's UV rays.
18X56 mesh, 280-300gsm, shading rate :75%
18X19 mesh, 525gsm, shading rate : 80%

Colour Options :



Spline, Tools & Repair Parts

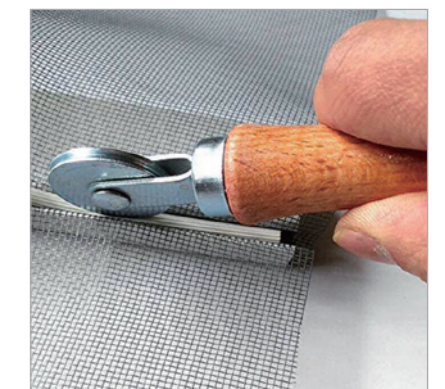

Repair Patches & Tape

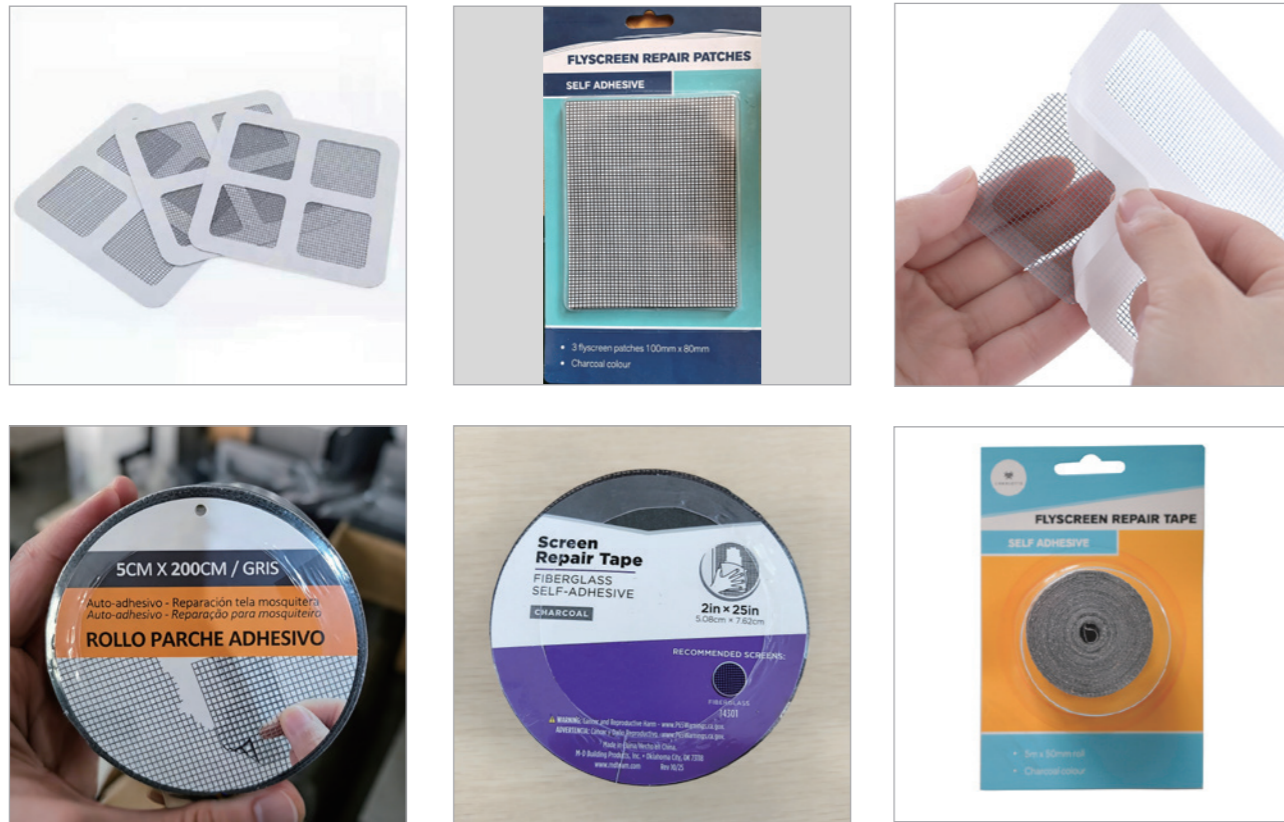

Packaging

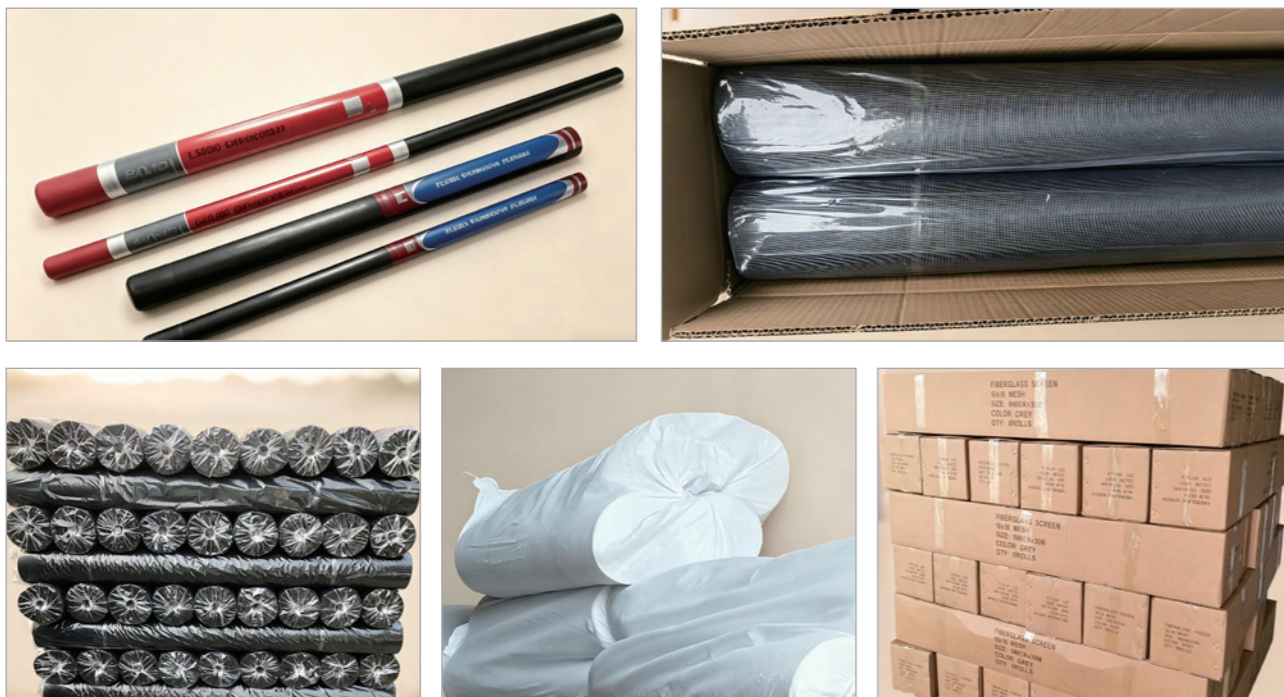

05

Electric Insect & Mosquito Killer Series

ELECTRIC BUG ZAPPER

1. PC/ABS resin casing, fire-retardant & easy to process.
2. Timeless stylish design, cost-effective & perfectly sized.
3. Upgraded technology, soft glow for universal use.
4. Supports adjustable power: 1×4W, 1×6W, etc.
5. Suitable for both indoor & outdoor use.





UV INSECT KILLER LAMP

1. 360° full coverage, 365nm UV light for insect attraction.
2. UV LED beads with long lifespan.
3. Built-in high-voltage grid, instant kill.
4. Removable bottom insect tray with free cleaning brush included.
5. Suitable for commercial & large household spaces.

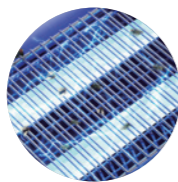

RECHARGEABLE ELECTRIC MOSQUITO SWATTER

1. ABS engineering plastic casing, fire-retardant, shockproof & easy to clean.
2. High-efficiency LED light for enhanced insect attraction.
3. Foldable dual-use design, cost-effective & perfectly sized.
4. Optional battery capacities: 800mAh, 1200mAh, 1800mAh, etc.

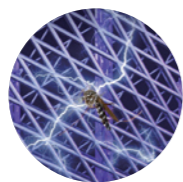

06

Aluminum Profiles & Accessories



Flat-Edge Cabinet Handle Profiles



Surface-Mounted Cabinet Handle Profiles

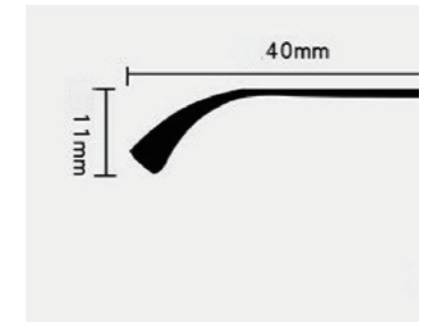

Cabinet handle

Height: 18mm

Width: 40mm

Length: 80mm、120mm、150mm、
200mm、300mm、400mm、500mm、
600mm、800mm、1200mm、
1500mm、1800mm、2100mm、
2400mm、2700mm、2800mm



hole= C	L	W	H
96	120	15	16
120	150	15	16
160	180	15	16
320	340	15	16

Multi-Purpose Aluminum Trim Profiles

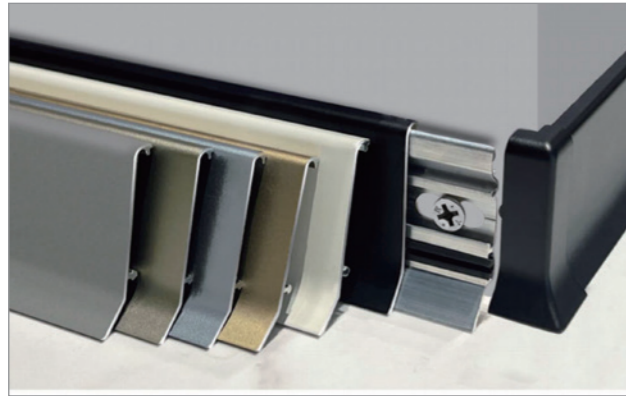

Trendy Skirting Board Series

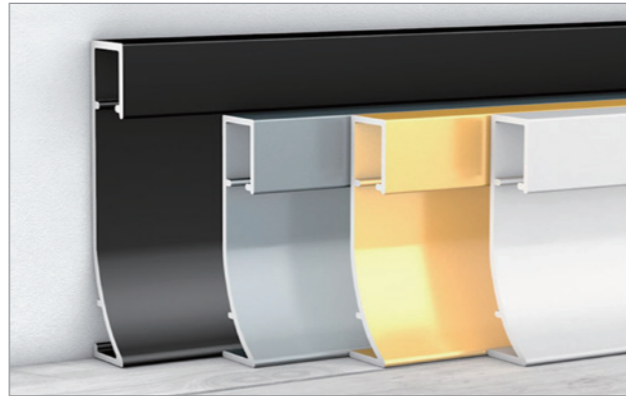

LED Recessed Skirting Board Series

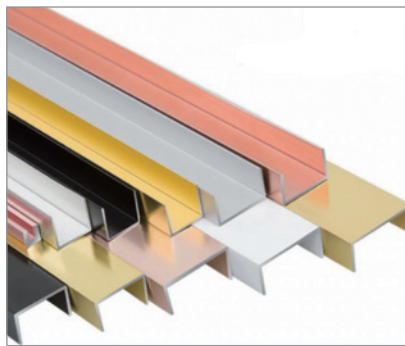

U-Shaped Channel Profile Series



Curved-Edge Recessed Skirting Series

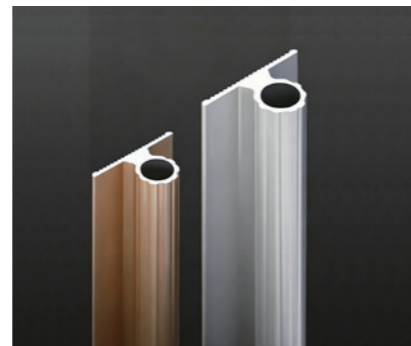

Cabinet Door Straightener Profile Series



T-Shaped Floor Transition Strip Series



Modern Cabinet Handle Profile Series

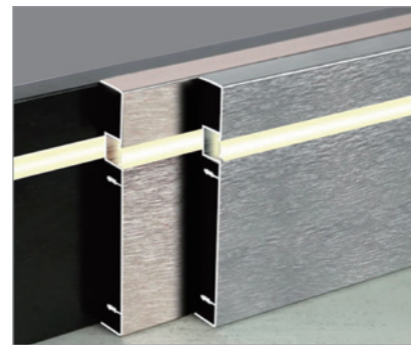

Surface-Mounted LED Skirting Board Series



Wall Top Trim Profile Series



Stair Nosing & Corner Protection Series



Frame & Jamb Profile Series

Flat-Edge Cabinet Handle Profiles

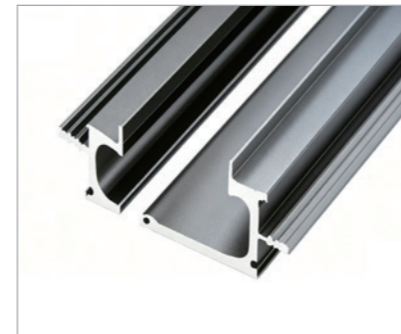

HK-9380a

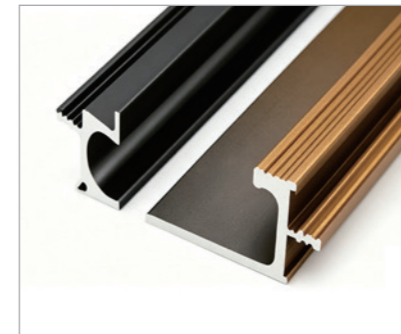

HK-548L



HK-8646



HK-871/872

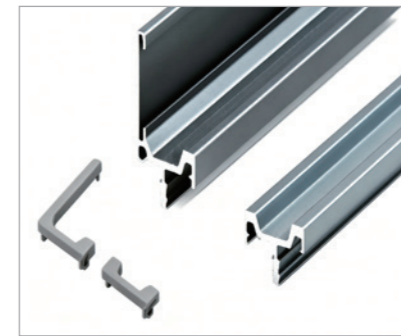

HK-8236/8237

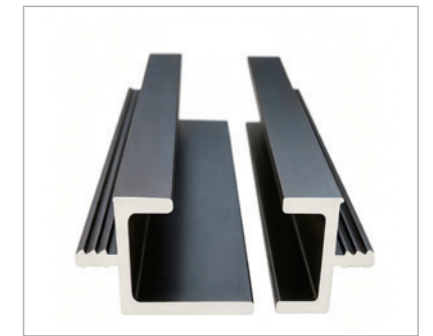

HK-541

Solar PV Frame & Bracket Aluminum Profiles

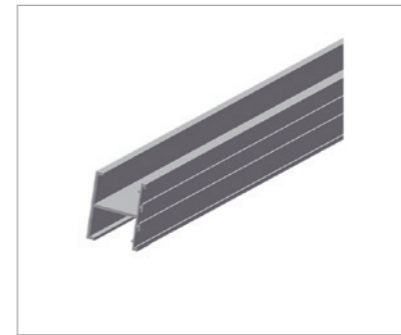

AS003/Aluminum Alloy

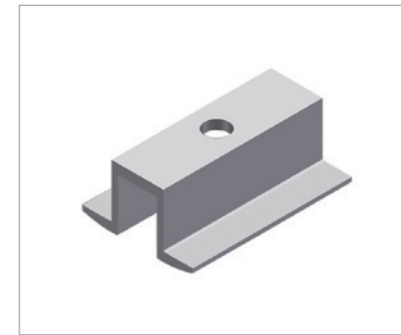

Single hole medium pressure/
Aluminum Alloy

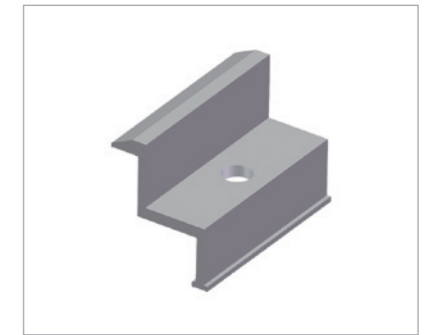

Single hole edge pressure/
Aluminum Alloy

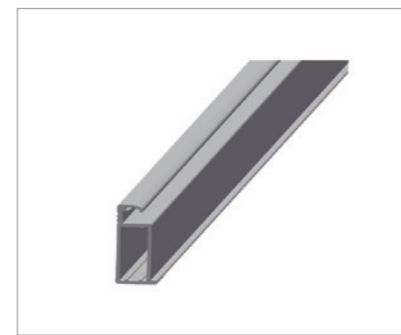

Short frame/Aluminum Alloy

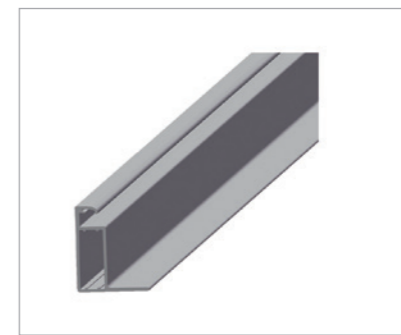

Long frame/Aluminum Alloy



Aluminum corner code/Aluminum Alloy